



Metal Backed 'A' & 'C' series with sidecast

AUSTRALIAN MADE • AUSTRALIAN OWNED

CONGRATULATIONS and thank you for purchasing one of our new range of "Graphite" reels as your choice of fishing reel. This range of reels is constructed from the highest quality materials to ensure your reel will last for many years. Combining the lightness and strength of graphite in the back with a tough polymer alloy spool on your reel will make it balance beautifully on today's light graphite/fibreglass composite rods giving you the ultimate fishing outfit.

Small reels in this range feature our famous "Easy Cast" System. Just hold the spool of the reel turn 90 degrees to the casting position (no levers or buttons to press). These reels can be used right hand or left hand. The **600 & 650 series** casting system still incorporate our strong and reliable metal side cast system to give smooth long accurate casts.

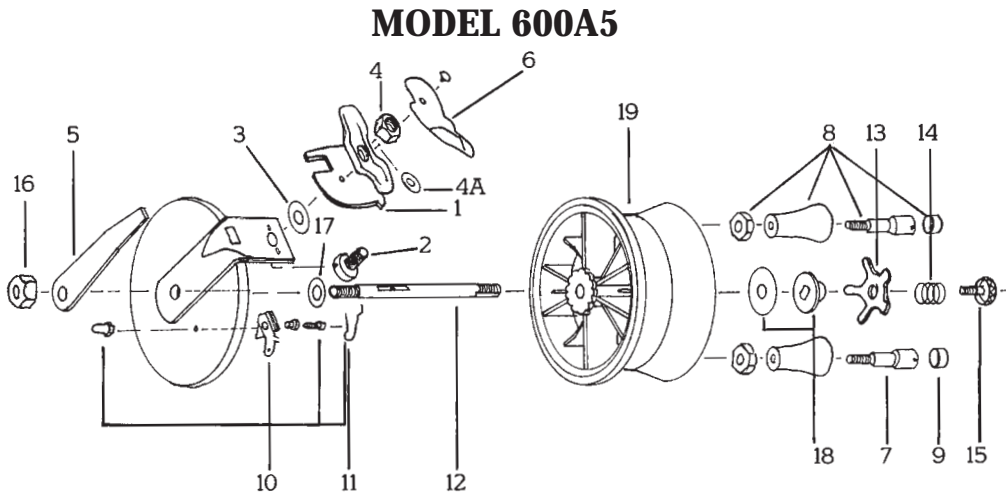

KEY NO.	DESCRIPTION	PART NO. 600A5
1	Base Assembly	R2A1
2	Base Bolt	R2D2
3	Base Washer (Micarta)	R2E1
4	Base Bolt Nut	R2F1
4A	Base Washer (Stainless Steel)	R2L1
5	Base Lock Spring	R2G9
6	Base Lever & Rivet	R2H1
7	Handle Screw	R4E4
8	Handle Assembly	R4F4
9	Handle Plug	R4H1
10	Ratchet Assembly	R5E3
11	Ratchet Spring	R5F2
12	Spindle	R6A8
13	Spindle Nut	R6B6
14	Spindle Spring	R6C3
15	Spindle Screw	R6E3
16	Spindle Hex Nut	R6F1
17	Spindle Fibre Washer	R6J4
18	Spindle Nylon Washer & Fibre Washer	R6O2
19	Spool with Handles	R4B

Plus all these other advantages...

LONG, ACCURATE CASTS:
Now, with only the minimum of practice following Alvey instructions, you'll be able to cast further and more accurately than ever before.

CONTROL LARGE FISH WITH EASE:
Powerful one-to-one direct wind means you only need about a quarter of the effort required to lift a similar weight on a spinning reel.

YOU CAN FISH HARDER AND LONGER:
Simple, rugged construction means you can forget that fiddly maintenance, because your Alvey reel will resist the effects of salt water and sand.

MORE COMFORTABLE FISHING:
Low winch mount rods let you fish with your arms in a relaxed position.

DID YOU KNOW Alvey reels are fish sensitive?
Angling with an Alvey side-cast or boat reel means you're using a system that lets you 'feel' the bite directly through the handles as well as through the fingers you use to guide the line. No other reel gives you this unique direct contact with your bait or lure- and the fish.

NO LINE TWIST:
Use a small free-running swivel as the last piece in any rig and you'll never have line twist. (See illustrations inside)

GUARANTEE AGAINST FAILURE:
If your Alvey reel should ever fail because of faulty workmanship or materials, just return it to the place of purchase or to the factory and we'll repair it. Without charge.

Should replacement of drag or ratchet action springs be necessary refer to the illustration below.

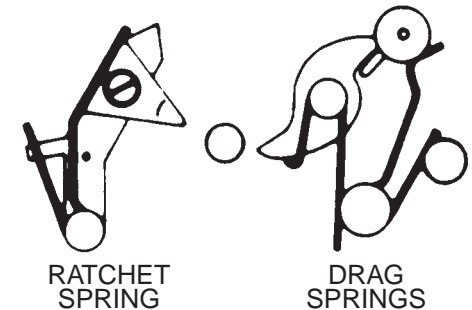

RECOMMENDED LINE SIZE

For fish up to 1kg use 3 to 4kg line, gamefish 1 1/2 to 2 1/2kg use 5 or 6kg line, for larger fish use 7.5 to 10kg line. If fishing near rocks or other hazards use heavier line to help avoid line breakage.

FILLING THE SPOOL WITH LINE

Always take the line from the front of the dispenser, never the side.

Wind on firmly and evenly onto the spool, spreading the line to give a smooth casting base.

Never stretch a nylon monofilament onto a spool, when it goes back to its original length it will exert strong enough crushing action to damage your spool. Never allow loose coils to develop on your spool through careless uneven winding. Adopt the habit of applying light finger tension while the line is spread evenly over its bed.

The simple method for LONG DISTANCE SURF CASTING with the world's best side-cast reel - ALVEY!

1. To begin, place fingers of left hand on spool lip and thumb on release lever. Press lever... turn spool

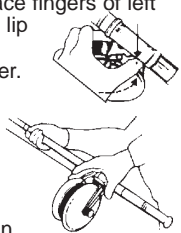

2. Turn spool a full quarter to open-face casting position.

3. Release line from open runner. Restrain line with thumb on spool.



4. Casting position: Arms high rod held over shoulders, reel above rod.

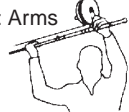

5. Casting action: Punch hard with right hand, pull downward with left hand.



6. Casting drive: Follow through while releasing line grip as power is applied. Rod butt must clear left leg.



7. End of cast: Trap line at reel base. Turn drum back to fishing position.



8. Return line to open runner.

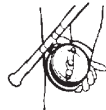

9 & 10 A comfortable fishing position makes hooking, playing or landing a fish more efficient.



If you're left-handed simply carry out above instructions the other way round.

SELECTING A ROD

Your rod and reel outfit should be designed so you can hold it comfortably over long periods. A matched set, which has a point of balance where its held in the left hand, will give you the most comfortable posture.

The use of a short butt brings the reel into a natural position for rewinding with your elbows at your side and without strain.

LIGHT CASTING

For most river, lake and estuary fishing the single handed cast method shown below in fig. 1. is all that is required. Just turn the reel to 90° to the casting position, holding the line on the lip of the reel with your L.H. index finger.

Now with a smooth even casting action cast your rod and release line. This method can be used overhead, underhand, backhand or forehand to avoid trees or obstacles.

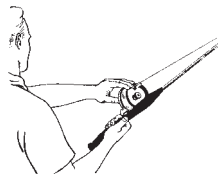

All reels that cast from the side of a stationary spool give maximum unrestricted casting, free from snarls or backlash, but it's essential that a small free running swivel is used as the last item above the rig.

The swivel must be above the weight. Whatever the rig always use the smallest practical swivel above any attachment to the line.

SWIVEL SIZES

Size No. 12 Lines 3 to 5kg breaking strain.
Size No.10 Lines 6 to 7kg breaking strain
Size No.8 Lines 10 to 12kg breaking strain.
Size No.6 Lines 12 to 17kg breaking strain.

TYPES OF RIG

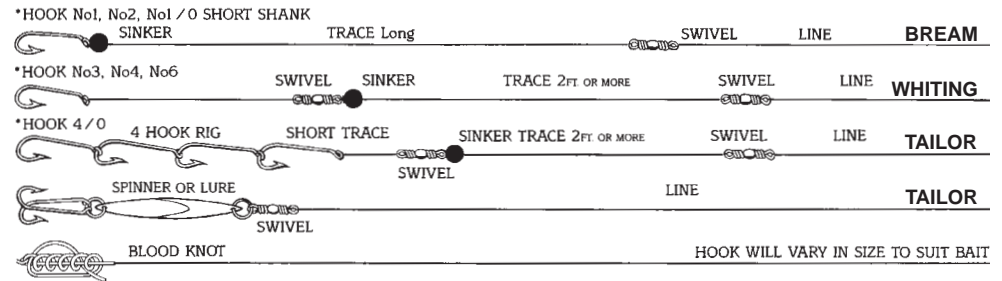

ALVEY 'A' SERIES

DIRECT WIND REEL - MODELS A1 & A5

The ultimate in simplicity of construction, with the absolute minimum of wearing parts. 'A' Series reels have no star drag action. As the fish makes its run, even-line tension is maintained by the angler taking his or her fingers from the winding handle and putting them under the reel against the line still left in the spool well.

ALVEY 'C' SERIES

NON-REVERSING DRAG MODELS - C1 & C5

Incorporating a multi-plate friction clutch on larger models these reels give a wide range of tension settings which don't vary once set while battling with the fish, but the drag control star nut is positioned in such a way that adjustments can be made while the fish is played. With the pawl knob engaged, the handle locks in a stationary position while the spool continues to give line to the running fish.

SETTING THE DRAG

The drag system allows line to be pulled from the reel under tension without breaking when a fish strikes, or makes a quick run when hooked. Set the drag by turning the anti-reverse 'on' then pull the line against a small hand scale. Adjust

the drag tension from one third to no more than half the line's ideal strength. It's better to start fishing with the drag set too loose than too tight, and tightening it when the fish is on. If too tight, the line may break. Always loosen the drag completely after fishing.

ALVEY 'E' SERIES

POSITIVE WIND STAR DRAG - MODEL E5

These reels combine the protection of the Alvey 'C' series with positive action of the 'A' type, and are available in Models 650, 651 and 700.

PLAYING THE FISH

Once the fish has been hooked always keep a bend in the rod by holding it at an angle to the fish. With the power of an Alvey reel, you only need to hold the rod up and wind in. If the fish is too strong, let go some line until it tires then rewind. With large fish, pumping with the rod will help in landing it.

MAINTENANCE

Use Alvey reel Lube for working spindles etc. Then light machine oil on handles and index mechanism. After each day's fishing wash off salt and sand and lubricate as above before storage. Unless major overhaul is required, there's no need to strip the reel complete

RIGS & SWIVELS

When used properly a brass swivel is a very inexpensive and efficient way to keep a fishing line in good condition.

Curls and twists in a line can be caused by many things, but can be kept to a minimum by a correct use of a swivel.